

CAUTION: The DPYH-1300U pyrometers are suitable for use in Class I, Group D, Division 1 and 2 hazardous locations when installed in accordance with these instructions.

The thermocouple leads connected to this device operate at very low voltage and power levels and **MUST NOT CONTACT** any external voltage source. Damage to the system will result from connection between the thermocouple leads and the ignition system or any AC or DC power source.

WARNING: DEVIATION FROM THESE INSTALLATION INSTRUCTIONS MAY LEAD TO IMPROPER OPERATION OF THE MONITORED MACHINE WHICH COULD CAUSE PERSONAL INJURY TO OPERATORS OR OTHER NEARBY PERSONNEL

1.0 DESCRIPTION

- 1.1 The Altronic DPYH-1300U digital temperature switch & gauges are electronic instruments designed to monitor temperatures using industry standard thermocouple probes. An LCD display is used to display the temperature value, the channel number, the units in °F or °C, and the high setpoint limit value. In addition, the monitored temperature is continuously compared against a high limit setpoint which is set by the operator from the front of the instrument; if the setpoint value for that point is exceeded, the corresponding normally-open switch turns on to ground and a corresponding normally-closed switch opens. Operating power is from capacitor discharge ignition systems from 100-400 volts or from 12-48 VDC.
- 1.2 The DPYH-1301U is a single point instrument with one high limit setpoint and output switch. A front panel push button switch and trim pot allow the user to display and adjust the high limit setpoint value.
- 1.3 The DPYH-1392U is a dual point instrument with two individual high limit setpoints and output switches. Front panel pushbutton switches and trimpots allow the user to select the desired thermocouple input point and adjust the corresponding setpoint value. The point selected and the monitored temperature are displayed continuously on the LCD display. Both thermocouple inputs are continuously compared against individual high limit setpoints which are set by the operator from the front of the instrument; if either setpoint value is exceeded, a normally-open and normally closed output switch corresponding to the particular monitored point are activated.
- 1.4 For proper operation, these installation instructions must be adhered to strictly.

2.0 MOUNTING

- 2.1 Mount the temperature switch & gauge inside a control panel or to a suitable flat surface so that the display is at a convenient viewing height. A drilling template is provided. This device fits the industry standard cutout for a round 4-1/2" diameter gauge. Be sure the enclosure door does not hit the pushbutton.

NOTE: Avoid mounting with the LCD display facing direct sunlight. The display temperature range is -40°F. to +175°F. The high temperature switch function operates over a range of -40°F. to +185°F

3.0 WIRING (SEE WIRING DIAGRAMS)

3.1 POWER WIRING - Connect the power input wires to the appropriate input terminals; either IGN for C.D. ignition power (100-400V) or +DC for 12-48 VDC power. Be sure to observe the correct polarity in making these connections. The GND terminal is connected to panel ground which should be the same as engine ground. DO NOT ground this device directly to the ignition system common coil ground. NOTE: Contact the factory for specific application information if the power input to the device is from a positive ground system.

3.2 HIGH TEMPERATURE SWITCH WIRING - An over-temperature condition actuates both normally open and normally closed solid state switches. The normally open switch, marked (N.O.+) closes to ground and the normally closed switch, marked (N.C.+ and -) opens. The DPYH-1301U single point instrument contains one each normally open and normally closed output switch marked SWITCH. The DPYH-1392U two-point instrument contains one each normally open and normally closed switch for each channel marked SWITCH 1 and SWITCH 2. The output switches are accessible through terminals on the back of the device. The solid state switches have an open circuit breakdown voltage rating of 400VDC, 0.10 amp (N.O. switch) and 48VDC, 0.50 amp (N.C. switch). The output switch will trip if the monitored temperature exceeds the setpoint value. The switch will also be activated if its associated thermocouple is not connected or becomes open-circuited. On the DPYH-1392U do not leave either thermocouple input open; connect either to a thermocouple or place a jumper across the input. If the high temperature switch will not be used, leave SWITCH 1 and/or SWITCH 2 terminals disconnected.

NOTE WHEN USING N.C. SWITCH:

1. The ground reference of the power source (C.D. ignition or DC power) must be connected to the GND terminal of the DPYH device for proper operation of the N.C. output switch.
2. The N.C. switch will be open with no power applied to the device.

3.3 THERMOCOUPLES AND THERMOCOUPLE EXTENSION WIRE - Grounded or ungrounded thermocouples may be used; ungrounded thermocouples are recommended where possible. Thermocouple extension wire of the type indicated on the back label of the device must be run from the device thermocouple terminals to each thermocouple sensing source. Use stranded thermocouple wire having a good moisture-resistant insulation such as PVC; for higher ambient temperatures, teflon or B-fibre insulated thermocouple wire is recommended. To insure an accurate signal is transmitted to the DPYH device, avoid any added junctions, splices, and contact with other metals. Take care not to damage the insulation of the thermocouple extension wire when installing and take precautions against later damage from vibration, abrasion, or liquids in conduits. In addition, it is essential that the following practices be adhered to:

- A. Never run thermocouple wires in the same conduit as the ignition wiring or other high energy wiring such as AC line power, etc.
- B. Keep secondary wires to spark plugs and other high voltage wiring at least eight inches (200mm) away from thermocouples and extension wiring.

3.4 HAZARDOUS AREA OPERATION - The DPYH device operates with non-incendive circuits and can be operated with suitable precautions in Class I, Group D areas.

- A. CLASS I, DIVISION 2, GROUP D - The DPYH-1300U device mounted in a suitable panel meets the requirements for Class I, Division 2, Group D hazardous areas.

- B. CLASS I, DIVISION 1, GROUP D - The DPYH-1300U devices may be operated as intrinsically safe if the following associated devices are used:**
- 1. Altronic barrier 690 107 or 690 108 when powered from a certified Altronic ignition system; or a CSA-certified zener barrier rated 30 volts max, 120 ohms min. when powered from a DC voltage source. A suitable barrier is Stahl part no.9001/01-280-165-10; follow the installation instructions supplied with barrier.**
 - 2. Altronic DA or DD annunciator system with 690 series power supply; connect the SWITCH output terminals of the DPYH-1300U device to the annunciator sensor inputs. In addition, the following requirements must be met (see NFPA standard No. 493):**
 - a. Thermocouple wires within the panel enclosure must be kept at least two (2) inches away from other wiring. Run thermocouple extension wires leaving the panel in a conduit separate from all other wiring and keep separate throughout the installation.**
 - b. Wiring to the sensors must have a grade of insulation capable of withstanding an AC voltage or 500 volts RMS.**
 - c. Ignition and fuel valve wires must be in separate conduits and junction boxes from thermocouple wires.**

3.5 TESTING THERMOCOUPLE LEADS - If it becomes necessary to check thermocouple to terminal-strip wiring with an ohmmeter or other checker, first disconnect the thermocouple from the DPYH device. This will prevent possible damage to the device's sensitive low voltage detection circuitry.

4.0 OPERATION

4.1 SET DISPLAY READOUT SCALE - Remove the screw cover from the back of the unit and place the toggle switch handle up for °F readout or down for °C readout. The selected scale is indicated on the right side of the LCD display.

4.2 TEMPERATURE READOUT - The device must be powered from a suitable power source wired in accordance with the attached Wiring Diagrams. Each time the device is powered-up, the temperature value of point 1 will be displayed. To read the temperature value on point 2 of the DPYH-1392U, momentarily push the PUSH TO READ/POINT 2 button on the front panel. The display will switch to the point selected by the momentary depression of the appropriate PUSH TO READ button. NOTE: If the PUSH TO READ button is held depressed, the setpoint temperature will be displayed.

4.3 SETPOINT ADJUSTMENT - The high temperature limit setpoints are read by holding the appropriate PUSH TO READ button for approximately 3 seconds. The channel number at the far left of the display will disappear and the reading will change from the thermocouple reading to the setpoint reading. To adjust the setting, keep the PUSH TO READ button depressed and use a small screwdriver to turn the adjustment until the display readout matches the desired temperature. Both setpoints are set in the same manner. Rotating the adjustment clockwise (CW) increases the setpoint, counterclockwise decreases the setpoint. The output switch will be activated when the monitored display readout exceeds the preset setpoint value. The setpoint values are retained indefinitely until altered. The standard adjustment range is:

**In degrees C. mode - +5°C. to +800°C.
In degrees F. mode - +32°F. to +1500°F.**

NOTE: To maintain the weatherproof integrity of the case, replace the cover over the setpoint adjustment screw.

GENERAL WIRING DIAGRAM

DPYH-1301U

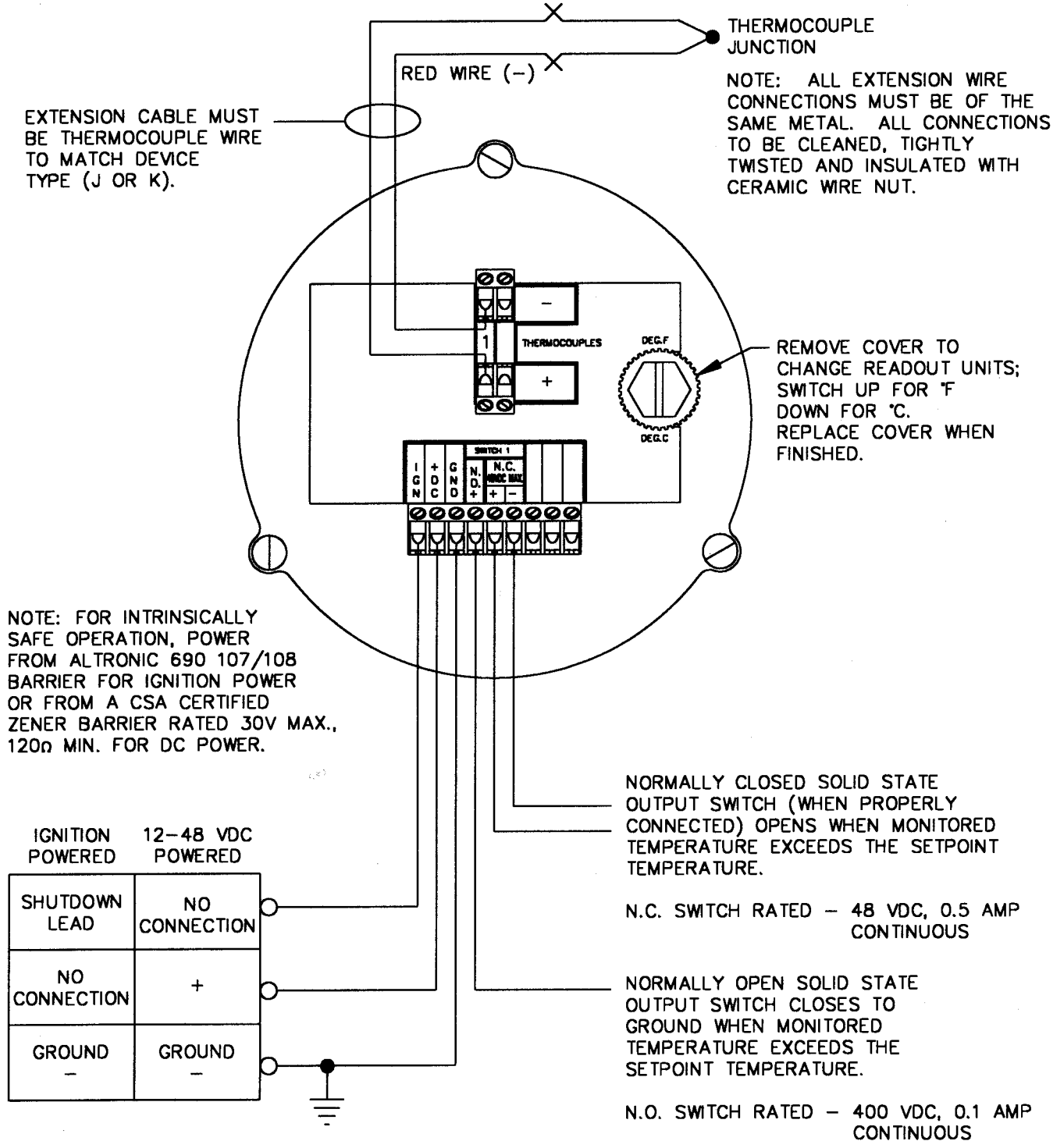

GENERAL WIRING DIAGRAM

DPYH-1392U

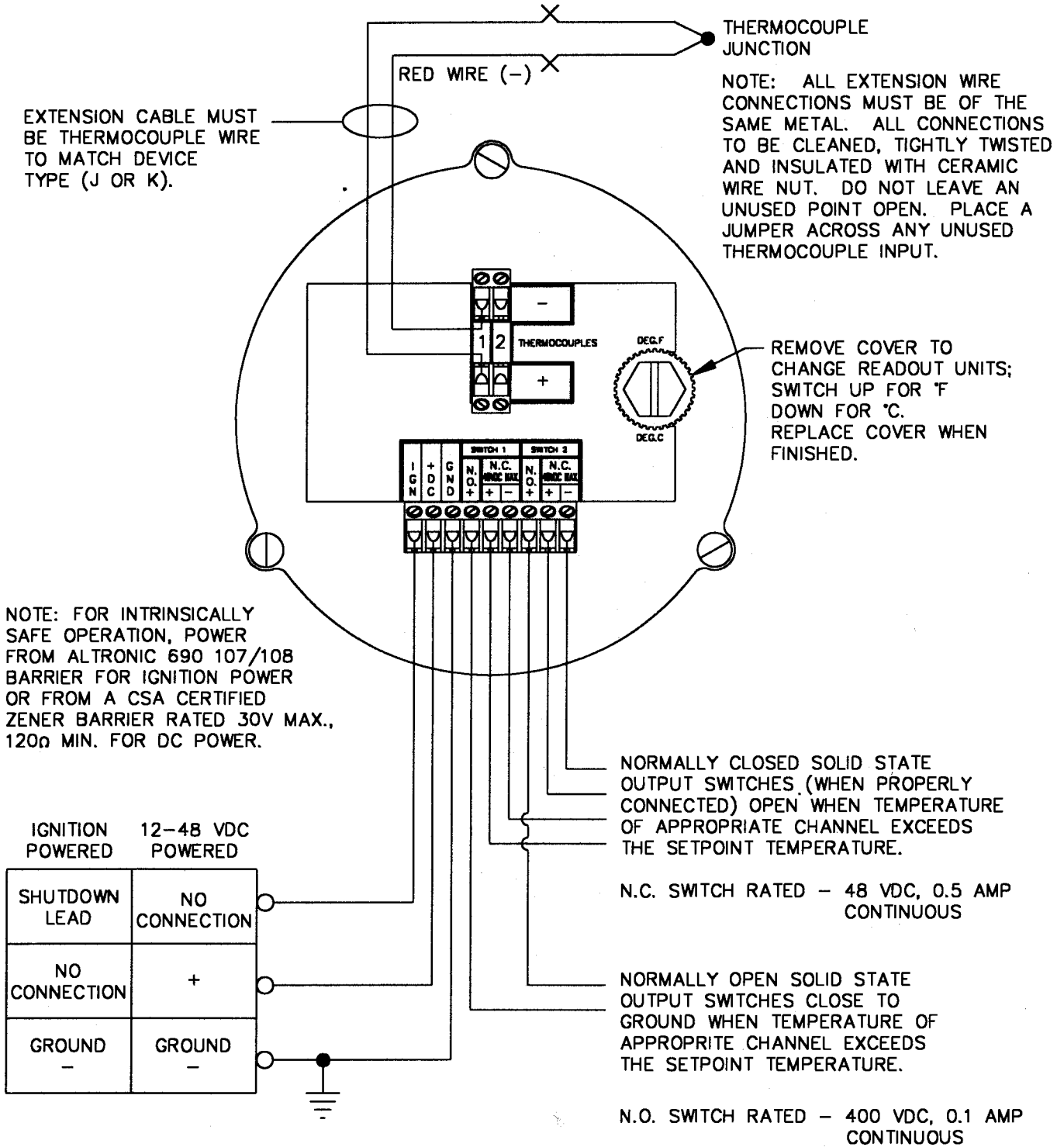

EXTENSION CABLE MUST BE THERMOCOUPLE WIRE TO MATCH DEVICE TYPE (J OR K).

NOTE: ALL EXTENSION WIRE CONNECTIONS MUST BE OF THE SAME METAL. ALL CONNECTIONS TO BE CLEANED, TIGHTLY TWISTED AND INSULATED WITH CERAMIC WIRE NUT. DO NOT LEAVE AN UNUSED POINT OPEN. PLACE A JUMPER ACROSS ANY UNUSED THERMOCOUPLE INPUT.

REMOVE COVER TO CHANGE READOUT UNITS; SWITCH UP FOR °F DOWN FOR °C. REPLACE COVER WHEN FINISHED.

NOTE: FOR INTRINSICALLY SAFE OPERATION, POWER FROM ALTRONIC 690 107/108 BARRIER FOR IGNITION POWER OR FROM A CSA CERTIFIED ZENER BARRIER RATED 30V MAX., 120Ω MIN. FOR DC POWER.

IGNITION POWERED	12-48 VDC POWERED
SHUTDOWN LEAD	NO CONNECTION
NO CONNECTION	+
GROUND -	GROUND -

NORMALLY CLOSED SOLID STATE OUTPUT SWITCHES (WHEN PROPERLY CONNECTED) OPEN WHEN TEMPERATURE OF APPROPRIATE CHANNEL EXCEEDS THE SETPOINT TEMPERATURE.

N.C. SWITCH RATED - 48 VDC, 0.5 AMP CONTINUOUS

NORMALLY OPEN SOLID STATE OUTPUT SWITCHES CLOSE TO GROUND WHEN TEMPERATURE OF APPROPRIATE CHANNEL EXCEEDS THE SETPOINT TEMPERATURE.

N.O. SWITCH RATED - 400 VDC, 0.1 AMP CONTINUOUS

WIRING DIAGRAMS

ALTRONIC ANNUNCIATOR SYSTEMS (IGNITION POWERED)

DPYH-1301U / DPYH-1392U

NORMALLY OPEN OUTPUT SWITCH WITH ALTRONIC ANNUNCIATOR USING NORMALLY OPEN SENSORS; C.D. IGNITION POWERED.

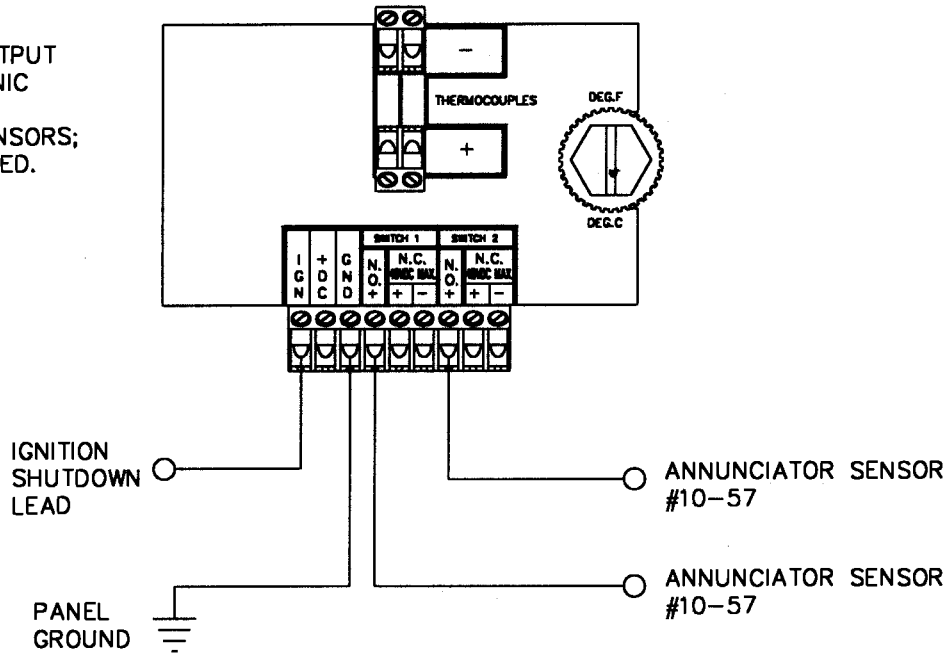

NORMALLY CLOSED OUTPUT SWITCH WITH ALTRONIC ANNUNCIATOR USING NORMALLY CLOSED SENSORS; C.D. IGNITION POWERED.

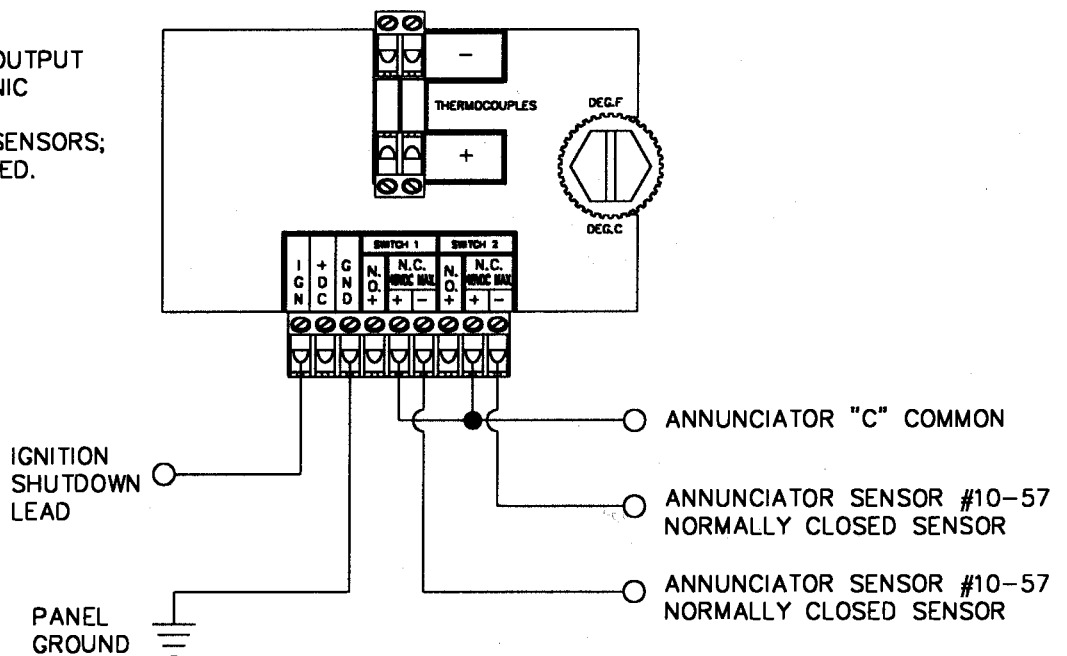

WIRING DIAGRAMS

ALTRONIC ANNUNCIATOR SYSTEMS (DC POWERED)

DPYH-1301U / DPYH-1392U

NORMALLY OPEN OUTPUT SWITCH WITH ALTRONIC ANNUNCIATOR USING NORMALLY OPEN SENSORS; DC-POWERED.

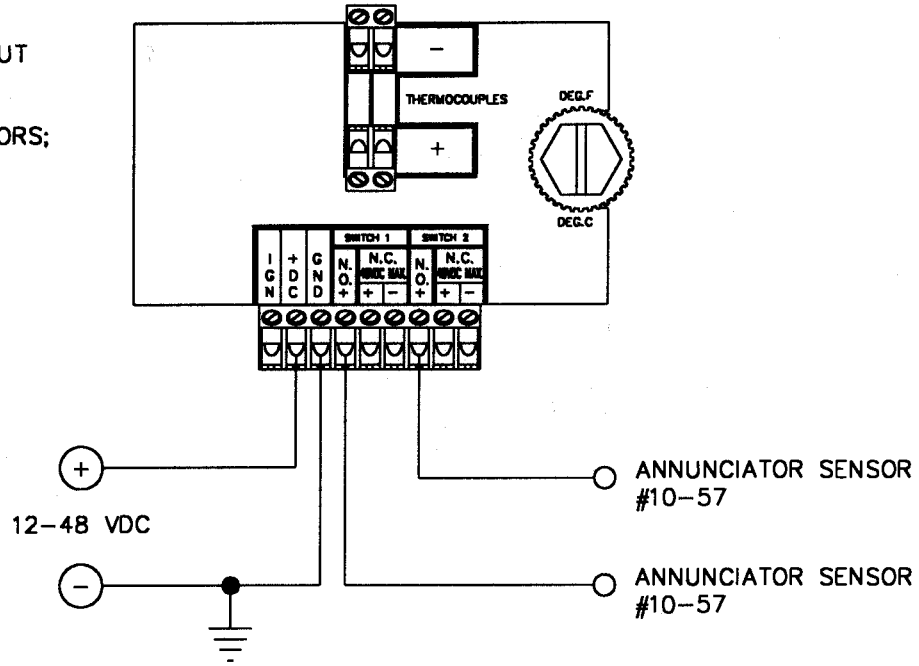

NORMALLY CLOSED OUTPUT SWITCH WITH ALTRONIC ANNUNCIATOR USING NORMALLY CLOSED SENSORS; DC-POWERED.

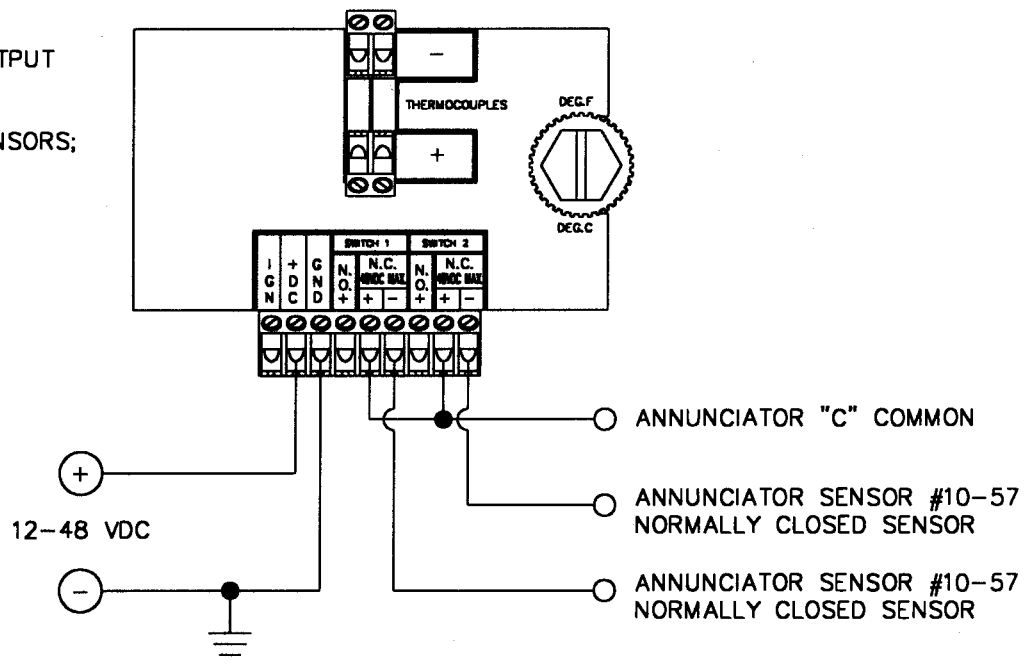

WIRING DIAGRAMS

MURPHY TATTLETALE (IGNITION POWERED)

DPYH-1301U / DPYH-1392U

NORMALLY OPEN OUTPUT SWITCH
 CONNECTION WITH MURPHY TATTLETALE
 OR PNEUMATIC VALVE;
 C.D. IGNITION POWERED - NEG. GROUND.

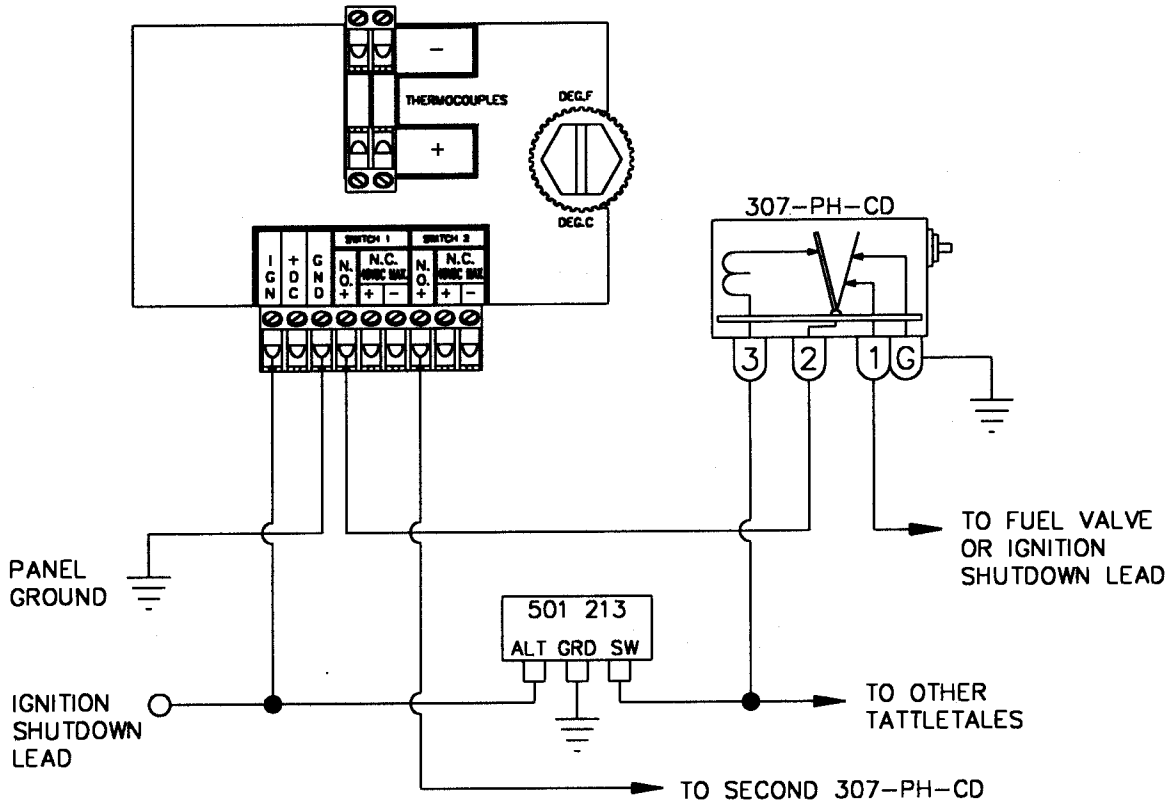

WIRING DIAGRAMS

DC RELAY or MURPHY TATTLETALE (12-48VDC POWERED)
DPYH-1301U / DPYH-1392U

NORMALLY CLOSED OUTPUT SWITCH CONNECTION WITH DC RELAYS;
12-48VDC POWERED.

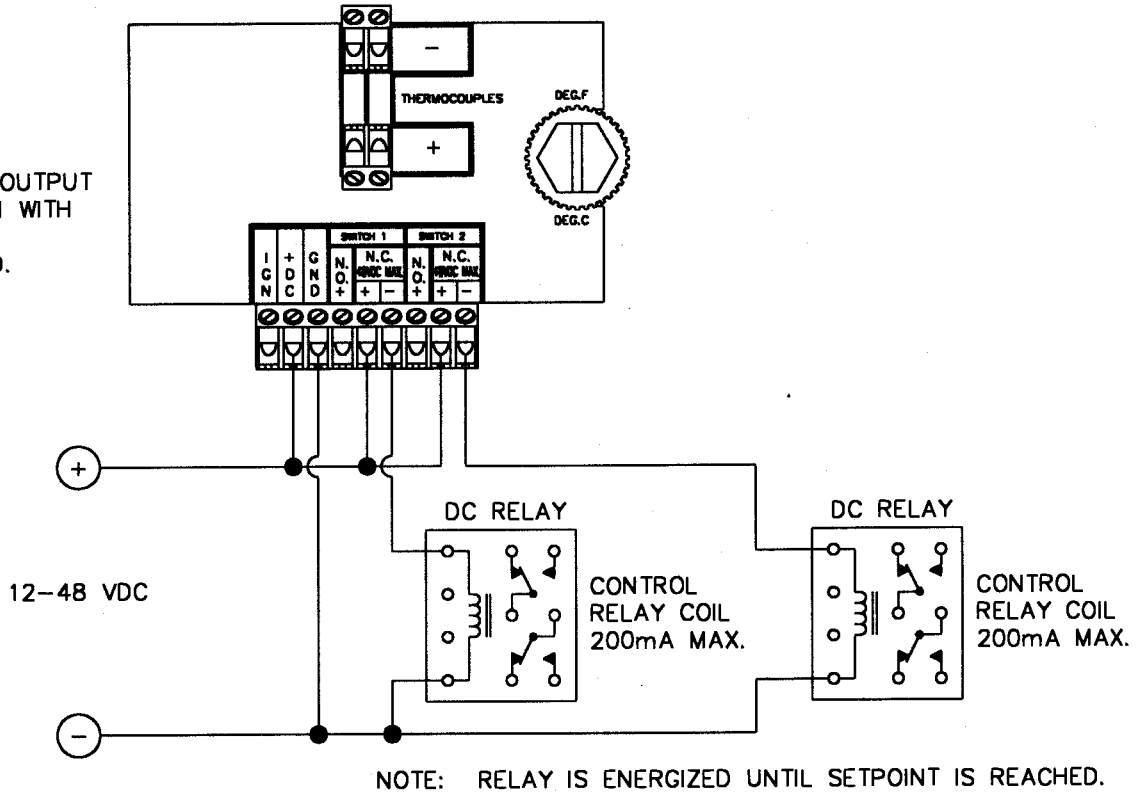

NORMALLY OPEN OUTPUT SWITCH CONNECTION WITH MURPHY TATTLETALE;
12-48VDC POWERED.

